

Go Mic

Portable USB Microphone for Recording



Owner's Manual

SAMSON[®]

THIS DEVICE COMPLIES WITH PART 15 OF THE FCC RULES CLASS B. OPERATION IS SUBJECT TO THE FOLLOWING TWO CONDITIONS: (1) THIS DEVICE MUST NOT CAUSE HARMFUL INTERFERENCE, AND (2) THIS DEVICE MUST ACCEPT ANY INTERFERENCE RECEIVED INCLUDING INTERFERENCE THAT MAY CAUSE UNDESIRE OPERATION. SUITABLE FOR HOME OR OFFICE USE.



Copyright 2009, Samson Technologies Corp.

Printed May, 2009 v1.1

Samson Technologies Corp.
45 Gilpin Avenue
Hauppauge, New York 11788-8816
Phone: 1-800-3-SAMSON (1-800-372-6766)
Fax: 631-784-2201
www.samsontech.com

Table of Contents

Introduction	2
Go Mic Features	4
Go Mic Layout	5
Installing the Go Mic	6
Getting Started with Windows XP	6
Getting Started with Windows Vista	9
Getting Started with MAC OS X	11
Operating the Go Mic	13 - 19
Go Mic Quick Start	13
Powering the Go Mic	15
Setting Up the Signal Level	15
Stand Mounting the Go Mic	15
Polar Patterns	16
Microphone Placement	16
P-Popping	17
Application Notes	18
Go Mic Specifications	20 - 21

Introduction

Congratulations on your purchase of the Samson Go Mic portable USB studio condenser. The Go Mic is a dual-pattern studio microphone featuring high quality onboard digital converters and USB interface fit into an extremely portable, fold-up design making it ideal for professional digital recording or webcasting. The Go Mic is a studio quality condenser microphone offering both unidirectional, or cardioid, and omnidirectional pick-up patterns, plus there's a 10 dB PAD for recording hot signals. The Go Mic's built-in audio interface features a robust headphone output allowing you to monitor your recordings. The clever clip design allows you to mount the microphone on your laptop or you can convert the clip mount to a convenient desk stand. You can even mount the Go Mic on a standard microphone stand with the included adapter. You get everything you need to get started recording on your computer including USB cable, cable clip, mic stand mount and handy carry case to keep your mic protected during transport. The Go Mic is perfect for recording any acoustic audio source on your favorite DAW (Digital Audio Workstation). Just plug in the supplied USB cable, launch your DAW and start recording. The Go Mic faithfully reproduces a variety of sound sources including vocals, acoustic string and wind instruments, percussion, and overhead cymbals, to name a few. It is also great for VoIP, chatting and webcasting. The extended frequency and fast transient response ensures an accurate reproduction with linear characteristics from bottom to top. Whether you're recording your latest song idea, a podcast, or your band's next big hit, the Go Mic is the simplest and most comprehensive solution for high quality recording on a Mac or PC. Just plug it in and start creating!

Introduction

In these pages, you'll find a detailed description of the features of the Go Mic USB Studio Condenser Microphone, as well as step-by-step instructions for its setup and use, and full specifications. You'll also find a warranty card enclosed—please don't forget to fill it out and mail it in so that you can receive online technical support and so we can send you updated information about these and other Samson products in the future. Also, be sure to check out our website (www.samsontech.com) for complete information about our full product line.

With proper care your Go Mic will operate trouble free for many years. We recommend you record your serial number in the space provided below for future reference.

Serial number: _____

Date of purchase: _____

Should your unit ever require servicing, a Return Authorization number (RA) must be obtained before shipping your unit to Samson. Without this number, the unit will not be accepted. Please call Samson at 1-800-3SAMSON (1-800-372-6766) for a Return Authorization number prior to shipping your unit. Please retain the original packing materials and if possible, return the unit in the original carton and packing materials. If you purchased your Samson product outside the United States, please contact your local distributor for warranty information and service.

Go Mic Features

- Compact, dual pattern studio condenser with built-in audio interface and USB digital I/O.
- Compatible with most any Mac and PC based Digital Audio Workstation that support the USB Audio class.
- Unique, fold up design with integral clip makes the microphone extremely portable and ideal for most recording solutions, especially for mobile laptop recording.
- The microphone's capsules are extremely detailed and the switchable Cardioid and Omni pick-up patterns make it ideal for recording voice, conferences, acoustic instruments and for just about any other sound source.
- The onboard headphone amplifier allows you to listen to your recording directly from the microphone, plus you can use the output to connect active studio monitors.
- A software controlled, analog direct monitor mode is provided for zero latency monitoring.
- Computer controlled analog Input Gain with Peak LED makes it easy to set the proper level and get a clean signal.
- The on-board, high quality AD converters with 16 Bit, 48K sampling rate provide better than CD quality recording.
- On the road, in the studio or in a fixed installation, the solid construction with die cast base make the microphone a reliable audio tool, day in and day out.
- A 10 foot USB cable, cable clip and mic stand adapter are included to easily set up the microphone right out of the box, plus you can keep it safe while carrying it in the included zipper pouch.
- The Go Mic is perfect for recording voice, music, live instruments, podcasts, or for chatting and VoIP.

Go Mic Layout

- 1. Windscreen** – Dual stage grill protects the capsules and helps reduce wind noise and p-popping.
- 2. Capsules** – Dual, internally shock isolated 10mm capsules provide both Cardioid and Omni polar patterns.
- 3. LED** – The dual color Power/Clip LED lights green to indicate power, and flashes red when the input signal is clipping.
- 4. Diecast Base** – The molded zinc base is weighted and shock isolated to provide a sturdy solution for desktop applications.
- 5. Mic Stand Mount** – A standard Euro-mount mic stand mounting hole and included adapters allow you to attach the Go Mic to a standard microphone stand.
- 6. Clip** – Integral mounting clip for easy set-up and installation up on just about any laptop computer.
- 8. USB** – Mini-B size USB connector for interfacing with your PC or Mac.
- 7. Phones** - 1/8-inch (.35mm) stereo jack for connecting headphones or studio monitors.
- 9. Pattern switch** – Selector switch used to set the microphone for Cardioid, Cardioid with a 10 dB Pad, or Omni pick-up pattern.

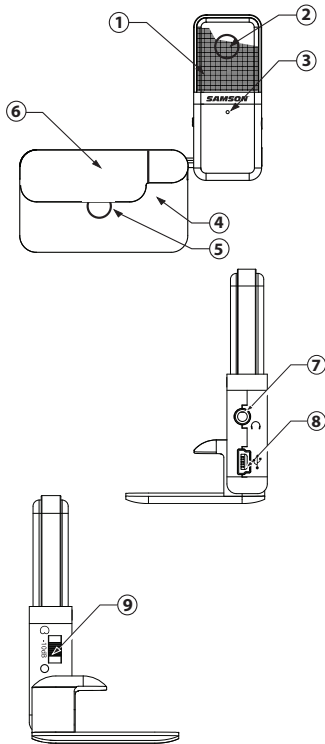

Installing the Go Mic

Installing the Go Mic is a simple procedure that takes just a few minutes. Since the Go Mic is USB compliant, you can use either a MAC or PC, connect the included USB cable and plug and play. You will be able to control your Go Mic using the standard audio interface controls in the MAC or Windows operating system. You will find detailed instructions on setting up with MAC OS and Windows in the following sections of this manual.

Getting Started with Windows XP

1. The first time you plug the Go Mic into a USB port, Windows will install the universal drivers for that port. A balloon tip will pop up, telling you it has “Found new Hardware” (figure 1).
2. When it is finished installing the drivers, it will say “Your new hardware is installed and ready to use” (figure 2).

Note: This balloon will not pop up again for the same USB port.

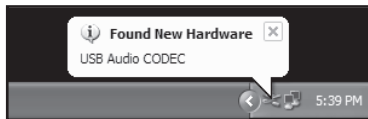

Figure 1

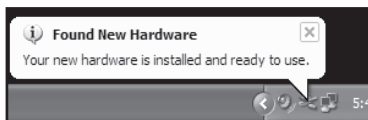

Figure 2



Figure 3

Installing the Go Mic



Figure 4

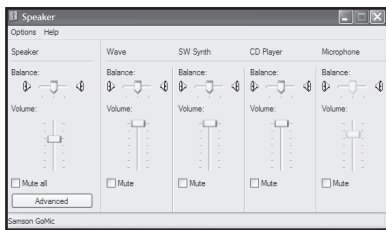

Figure 5

3. To set the Go Mic as your default device for sound playback and recording, or to change its settings, click the **Start** button, click **Control Panel** and then click **Sounds and Audio Devices**. Under the **Audio** tab, you can select the Samson GoMic from the drop-down menus. (figure 3).
4. To set the gain of the microphone, click the **Volume** button in the **Sound recording** section to make the **Microphone** slider appear (figure 4). It will say "Samson Go Mic" in the status bar at the bottom. Moving this slider will adjust the analog amplifier circuitry in the microphone.
5. To set the direct monitoring level or the playback volume in the headphones, click the **Volume** button in the **Sound playback** section instead. Adjusting the **Speaker** slider on the left changes the headphone level (figure 5). To turn off the zero-latency hardware monitoring direct monitoring (if you want to use software play-through with effects instead), click

Installing the Go Mic

the **Mute** checkbox in the **Microphone** section on the right. (If the Microphone section does not appear at first, click **Options** and then **Properties** (figure 6), and click the checkbox next to **Microphone**. (Figure 7)

6. To prevent system sounds from coming through the Go Mic, select a different sound card for the system default, and then choose the Go Mic manually within your DAW software.

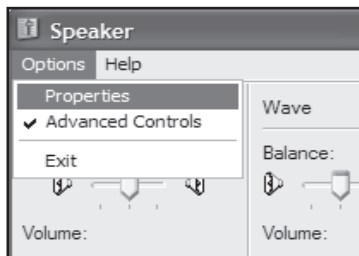

Figure 6

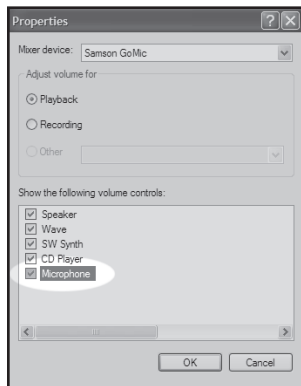

Figure 7

Installing the Go Mic

Getting Started with Windows Vista

1. The first time you plug the Go Mic into a USB port, Windows Vista will install the universal drivers for that port. A balloon tip will pop up, telling you it has “Found new Hardware”.
 2. When it is finished installing the drivers, it will say “Your new hardware is installed and ready to use”.
- Note: This balloon will not pop up again for the same USB port.*
3. To set the Go Mic as your default device for sound playback and recording, or to change its settings, click the **Start** button, click **Control Panel** and then click **Sound**. Under the **Playback** and **Recording** tabs, you can select the Samson GoMic from the menus and use the Set Default button to set it as the default device. (figure 8).
 4. To set the gain of the microphone, make sure the Samson GoMic is selected in the **Recording** tab and click the **Properties** button. Under the **Levels** tab, move the **Microphone** slider to adjust the analog amplifier circuitry in the microphone (figure 9).

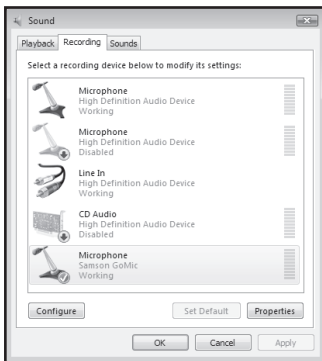

Figure 8

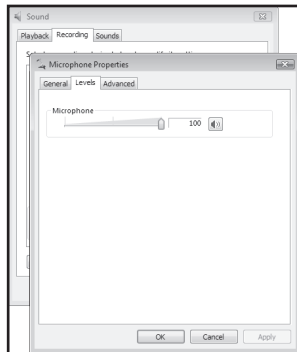

Figure 9

Installing the Go Mic

5. To set the direct monitoring level or the playback volume in the headphones, click the **Properties** button in the **Playback** tab instead, and open the **Levels** tab. Adjusting the **Speakers** slider changes the headphone level. To turn off the zero-latency hardware direct monitoring (if you want to use software play-through with effects instead), click the **Mute** button (speaker symbol) in the right of the **Microphone** section (figure11).

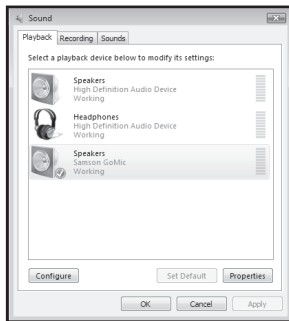

Figure 10

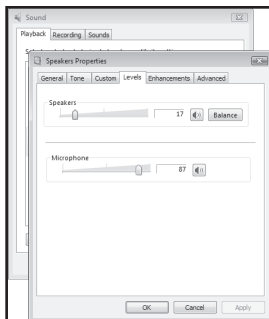

Figure 11

Installing the Go Mic

Getting Started with MAC OS X

The following example is for setting up the Go Mic in MAC OS X.

1. To start using the Samson Go Mic, just plug it in. The LED will light to indicate it is receiving USB power. The MAC will recognize the USB audio device and automatically install a universal driver.
2. To select the Go Mic as the computer's audio input, open the **System Preferences** from the dock or the main **Apple Menu** (figure 12).

Plug and Play - Some MAC OS DAW's, like Apple's Garage band, will let you plug and play without going to the Sound preference set up. When you plug the Go Mic into the USB port you'll see a dialog box that will ask you if you want to select the Go Mic. Select yes and you're ready to go.

3. Next open the **Sound** preference (figure 13).
4. Now, click in the **Input** tab and select Go Mic (figure 14).
5. To set the gain of the microphone, adjust the Input volume slider at the bottom of the Sound dialog box.
6. Next, click in the **Output** tab and select Go Mic.

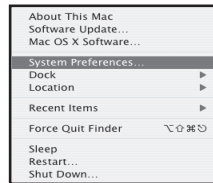

Figure 12

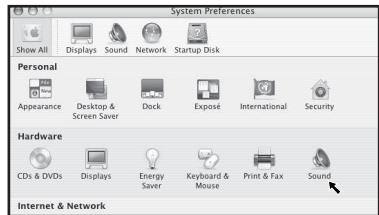

Figure 13

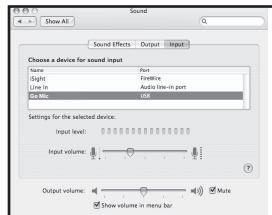

Figure 14

Installing the Go Mic

7. To set the playback volume in the headphones, adjust the **Output** volume slider at the bottom of the **Sound** dialog box (figure 15).

At this point you can begin using your microphone with most any audio recording software, but you need to select it as an input and output device within the DAW. When selecting the inputs and outputs just look for and select the Go Mic.

When recording in your DAW with monitoring turned on, you may experience a delay on the signal playback, commonly known as latency. The amount of latency depends on the speed of your computer, available memory and the number of tracks you are recording. You can set the Go Mic to Direct Monitor mode to listen to the signal directly off the input of the microphone to eliminate the latency.

Using the Direct Monitor

1. To turn direct monitoring on or off, open the **Audio/MIDI Setup** (figure 16) utility located in the **Utility** folder inside the Applications folder.
2. Now click the checkbox in the **Thru** column in **Audio/MIDI Setup**.

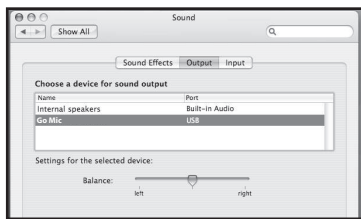

Figure 15

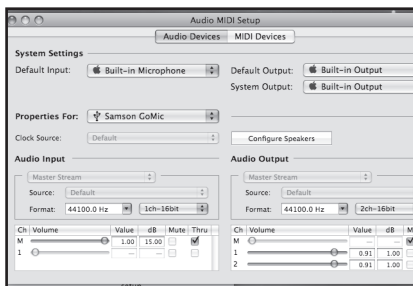

Figure 16

Operating the Go Mic

Go Mic Quick Start

You will find a detailed description of the Go Mic's controls and functions in the following sections of this manual. However, if you can't wait to get started, you can follow this quick start guide. Before you get going it's recommended that you follow the instructions on installing the Go Mic with either Windows or OS Mac in the previous sections of this manual. Once you confirm the Go Mic is connected to your computer properly, it will be easy to start recording. The more you learn about Go Mic, the more you'll discover its versatility and powerful features.

There are many ways to use the microphone, and our quick start example is for a typical set-up for recording vocals.

Just follow the simple steps below to start recording.

1. Unfold the Go Mic, press the clip in and set the microphone on the top of your laptop screen. If you prefer, you can position the Go Mic on your desktop by using back of the clip as a desk stand.
2. Set the Go Mic's pattern switch to Cardioid and be sure to face the front side, with the Samson logo, towards the vocalist.

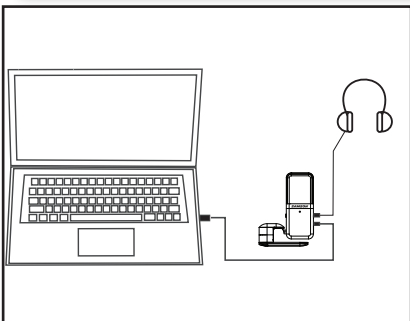
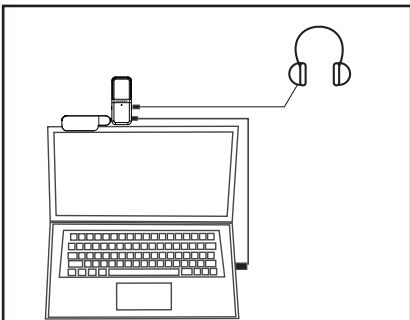

Operating the Go Mic

Go Mic Quick Start - continued

3. Next, connect your headphones to the PHONES output located on the right side of the Go Mic.
4. Plug the mini-B size (small) end of the included USB cable into the USB socket on the right side of the Go Mic.
5. Now, plug the other end of the USB cable into an available USB port on your computer.

Note: *Be sure to check the installation guide for Windows and Mac OS to confirm your computer has recognized the Go Mic. Also, make sure your computer's output level is set to maximum for full volume in the Go Mic headphone monitor.*

6. Next, launch your DAW, turn down the main output level and select the Go Mic for the input and outputs.
7. Set up a mono record track in your DAW for the vocal track.
8. At this point you want to set the level of the Go Mic and there are few ways to do this depending on your exact computer set up. You can set the microphone's input level in the Sound playback in Windows or in the Sound dialog box in the System Preferences if you are using the MAC OS.
9. Set level of the microphone by raising the Input level control in your DAW or system to about half way up. If you see the Power/Peak LED light red, your signal will be distorted. Turn the MIC level control down until it does not flash red.
10. Next, put on your headphones, speak or sing into the mic and then raise the DAW's output level control until you reach a comfortable listening level.

Now, follow the instructions of your DAW software to enable the track for recording and you're ready to record.

Operating the Go Mic

A Note on Powering the Go Mic

The Go Mic is a condenser microphone, and like all condenser microphones, it has internal electronics that require an active power supply. Traditional studio condensers are almost always powered by a Phantom Power supply which is usually derived from the mixing console. The Go Mic receives its power from the USB bus. Simply connect the microphone to the computer's USB port and the microphone is ready to operate. The Go Mic features a power on LED, which will illuminate when USB power is present.

Setting Up the Signal Level

You can adjust the Go Mic's internal analog input gain stage by using the your software DAW or operating system. The purpose of the level, or gain, controls are to optimize the amount of good signal relative to any associated noise. A good mic or instrument pre-amplifier, like the one inside Go Mic, will also have a PEAK indicator to show when the input signal is clipping. To set a good level on the mic, set the Go Mic up in front of the desired sound source and slowly raise the DAW's or operating system's input gain control until you see the CLIP or Peak indicator light up. Then, turn the input trim control down until the indicator does not light any more. Once you set the input level control you shouldn't need to change them during recording. Use the level controls on the DAW to set the balance between the mic and stereo mix.

Stand Mounting the Go Mic

The Go Mic can be mounted to a standard microphone stand like the Samson BT4, BL3 or MB1 using the included nut adapter. If you are using a U.S. 5/8" mic stand, you will need to screw on the included Euro stand adapter. Then install the nut spacing adapter. Simply screw the Go Mic on to your mic stand or boom arm. Now, using the ball joint, adjust the microphone to the desired angle.

Operating the Go Mic

Polar Patterns

The most important characteristic of any microphone is its directionality or “pick-up pattern”. There are three basic categories of pick up patterns; omni, bidirectional (or figure 8) and unidirectional. Omni mics pick up sound from all directions, bidirectional mics pick up the sound directly in front and back of the microphone while rejecting the sound on the left and right sides, and unidirectional (cardioid) mics pick up the sound in front of the microphone. While bidirectional microphones are very useful for a variety of applications, a majority of “miking” situations in recording require cardioid or omni microphones. The cardioid pick up pattern allows for better separation of instruments in the studio and more control over feedback in live sound reinforcement. When positioned correctly, the cardioid pick-up pattern allows you to pick up more of the sound you want and less of the sound you don’t want. If you need to pick up sound from all around, for example when recording a meeting around a conference table, the Omni pattern is ideal. When the Go Mic is set to Omni pattern it will pick up sound in a 360-degree pattern. This can also be used to pick up the ambient room sound for natural reverb when recording acoustic instruments.

Microphone Placement

In order to maximize the sound quality, you must pay careful attention to the placement of your Go Mic and how it is positioned for the instrument or vocalist that you are miking. All microphones, especially cardioid microphones, exhibit a phenomenon known as “proximity effect.” Very simply put, proximity effect is a resulting change in the frequency response of a microphone based on the position of the mic capsule relative to the sound source. In general, as the microphone moves closer to the sound source, the bass response increases. You can also make subtle changes to the frequency response by making minor adjustment to the position. Specifically, when you point a cardioid mic directly at the sound source (on axis) you

Operating the Go Mic

will get the best frequency response, however when you start pointing the microphone slightly away (off axis) you will notice the high frequency response dropping off and the microphone will start to sound like it has more bass and less highs.

For most vocal applications you'll want to position the microphone directly in front of the artist about 4 to 18 inches. If you are close miking a vocal, set the microphone to a slight angle to reduce p-popping. The same may be true for miking instruments, however, you can make some pretty amazing equalization adjustments by slightly changing the angle of the capsule to the sound source. This can be a very useful technique in capturing the optimum sound of drum set, acoustic guitar, piano or other instruments in a live room or sound stage. Experimentation and experience are the best teachers in getting good sounds, so plug in!

P-Popping

P-popping is that annoying pop that you can get when the microphone diaphragm gets a blast of air from a vocalist pronouncing words with the letter "P" included. There are a few ways to deal with the problem including using an external pop filter. Some famous engineers have relied on an old nylon stocking over a bent clothes hanger, which actually works very well. As mentioned above, you can also try placing the microphone slightly off axis (on a slight angle) from the vocalist. This can often solve the problem without using an external pop filter. However, the simplest, most reliable way to reduce P-popping (without the bad smell of old nylons) is to use a pop filter attached the microphone stand like the Samson PS-01. Using a pop filter also makes it easy to maintain a good level by keeping the vocalist at a constant distance from the microphone.

Application Notes

The Go Mic is a great microphone choice for many instrument miking situations. Below is a brief guide on using the Go Mic in some typical applications:

Vocals

Position the microphone directly in front of the artist so that the microphone grill is approximately 4 to 18 inches away. When close miking vocals, use of an external pop filter like the Samson PS01 is strongly recommended. You can use the Cardioid pattern to record a group of vocalists by positioning them around the front of the microphone. Just remember that the extreme sides of the microphone pick up less with less high frequency response, so have them stand together tight, and/or move the microphone from one to two feet away from the group to pick up more room sound. You can also set the pattern to Omni mode and have a group of vocalist in a circle around the microphone.

Acoustic Guitar

There are a variety of ways that the Go Mic can be used to mic an acoustic guitar. The microphone placement will depend on the type of instrument and what kind of sound you're looking to capture, for example the tonal quality you want to focus on, and how much finger slide or pick noise you may or may not want. When miking a standard steel string acoustic, a good place to start is with the microphone positioned and pointing towards the end of the fingerboard at a distance of about 6 inches to 2 feet away from the instrument. You can experiment by moving the microphone slightly in the direction of the sound hole, which will produce more low frequencies, or move it in the direction of the fingerboard to capture more high-end or to remove any unwanted boominess. For nylon string acoustic, try positioning the microphone above the bridge to emphasize more of the attack from the sound of the finger picking, or for less, move the mic closer to the sound hole. If you have a pair of Go Mics, try one positioned at the fingerboard and the second over the sound hole.

Application Notes

Piano

You can achieve outstanding results using the Go Mic on acoustic piano. Several placement approaches can be used depending on the size of the piano, and the type of sound you are looking to record. When miking a Grand Piano, (for an ambient sound like that used in a classical recital), a Go Mic can be positioned directly in front of the instrument. Open the lid to the full position and place the microphone five to twenty feet in front of the instrument. For a more contemporary ensemble sound, place two Go Mics in the piano, positioning one over the low strings and the other over the high strings.

Overhead Drum Kit

Because of its extended high frequency response and fast transient response, the Go Mic performs outstandingly when used as an overhead cymbal microphone. You can position one Go Mic on a boom mic stand directly above the kit pointing from front to back. For stereo miking, use two Go Mics placed over the drum set at a distance of three to five feet. You can experiment with the exact placement depending on the size of the room and whether you're looking for an ambient or close-miked sound. In general, when miking a drum kit, it's a good idea to start with the overhead mics. Even though you use the overhead mics mostly for the cymbals, you can get the entire kit to sound great with just one overhead. Then it will be easier to just bring up your individual mics for more attack and thickness in the overall sound.

Go Mic Specifications

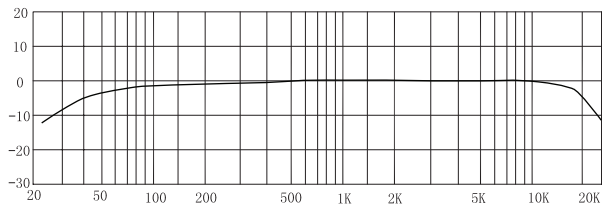

Go Mic Frequency Response - Cardioid

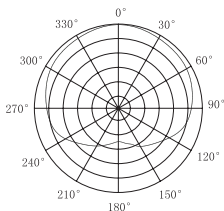

Polar Pattern - Cardioid

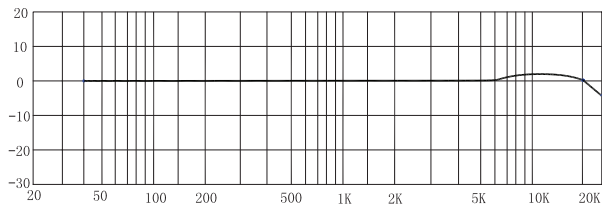

Go Mic Frequency Response - Omni

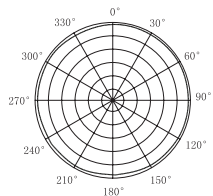

Polar Pattern - Omni

Go Mic Specifications

Go Mic Specifications

Polar pattern	Cardioid and Omni
Frequency Response	
Cardioid	80Hz - 18kHz
Omni	20Hz - 20kHz
Element type	Fixed Charge electret
Element Diameter	10mm
Diaphragm thickness	
Cardioid	4 microns
Omni	2 microns
Sensitivity	-47 +/- 2dB/Pa
SPL	121 db
Weight	0.23 lbs. (.105 kg)
Dimensions	2.8" x 1.7" x 2.3" x 0.9" 70.5 mm x 43.5mm x 23mm

Specifications subject to change without notice.

Samson Technologies Corp.
45 Gilpin Avenue
Hauppauge, New York 11788-8816
Phone: 1-800-3-SAMSON (1-800-372-6766)
Fax: 631-784-2201
www.samsontech.com